



18 GHz SMA LATCHING D.P.3.T. SWITCH

OPTIONS : INDICATOR /SELF CUT-OFF / TTL DRIVE

R F CHARACTERISTICS

FREQUENCY RANGE : 0 - 18 GHz
 IMPEDANCE : 50 Ohms

FREQUENCY (GHz)	0 - 3	3 - 8	8 -12.4	12.4- 18
V.S.W.R <=	1.20	1.30	1.40	1.50
INSERT. LOSS <=	0.20 dB	0.30 dB	0.40 dB	0.50 dB
ISOLATION >=	80 dB	70 dB	60 dB	60 dB
AVER. POWER (*)	240 W	150 W	120 W	100 W

ELECTRICAL CHARACTERISTICS

ACTUATOR : LATCHING
 NOMINAL CURRENT AT 25° C (±10%) : 420 mA
 ACTUATOR VOLTAGE (Vcc) : 12V (10 to 13V) / NEGATIVE COMMON
 TERMINALS : solder pins (250° C max./30 sec.)
 INDICATOR RATING : 1 W / 30 V / 100 mA
 SELF CUT-OFF TIME : 40 ms < CT < 120 ms
 TTL INPUTS (E) - High level : 2.2 to 5.5V / 800µA at 5V
 - Low level : 0 to 0.8V / 20µA at 0.8V

MECHANICAL CHARACTERISTICS

CONNECTORS : SMA female per MIL C 39012
 LIFE : 10.000.000 cycles
 SWITCHING TIME (nominal voltage;25° C) : < 10 ms
 CONSTRUCTION : splashproof
 WEIGHT : < 100 g

ENVIRONMENTAL CHARACTERISTICS

OPERATING TEMPERATURE RANGE (°C) : -40 , +85
 STORAGE TEMPERATURE RANGE (°C) : -55 , +85

(* : average power at 25° C)

This information is given as an indication. In the continual goal to improve our products, we reserve the right to make any modifications judged necessary

4112-9212

DRAWING

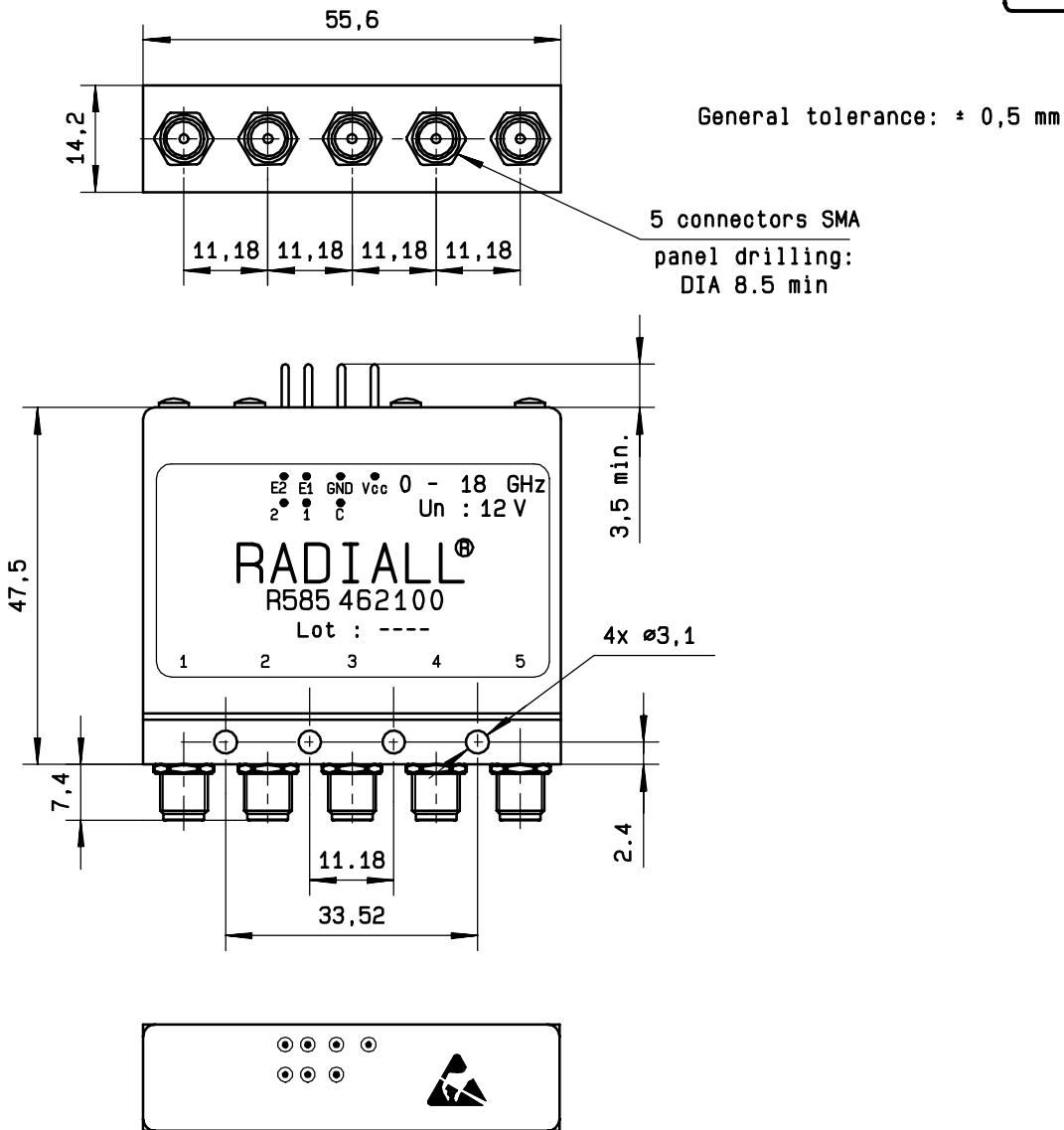

SCHEMATIC DIAGRAM

Voltage	RF continuity	Indicator
E1=1 E2=0	1 ↔ 2 / 3 ↔ 4	C . 1
E1=0 E2=1	2 ↔ 3 / 4 ↔ 5	C . 2
E1=0 E2=0	Memory	—
E1=1 E2=1	Forbidden	—

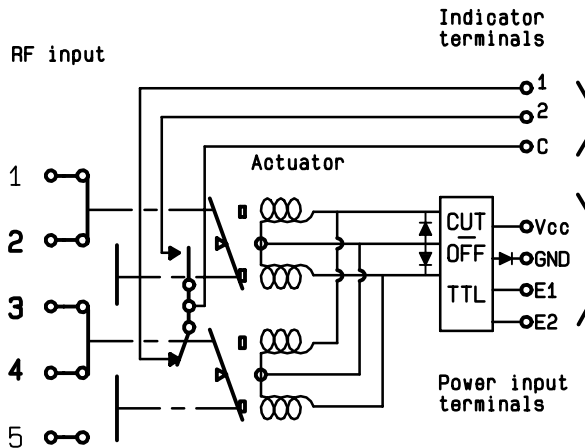

4113-9212 This information is given as an indication. In the continual goal to improve our products, we reserve the right to make any modifications judged necessary